

# SEATER

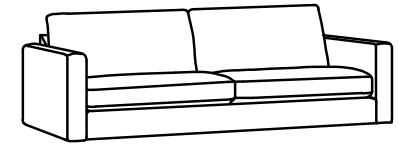



VILMA 3-sits

WITH ARMRESTS

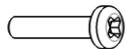
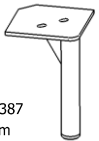

MODULAR SOFA

I

A	8	
B	4	No. 387 15 cm 
C	1	No. 87 15 cm 
D	8	Plastic 
E	1	Metal 

II

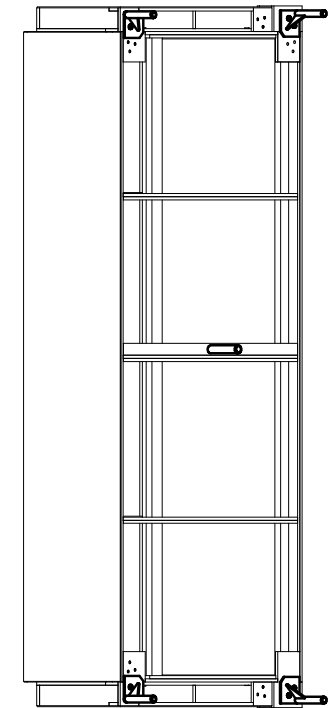
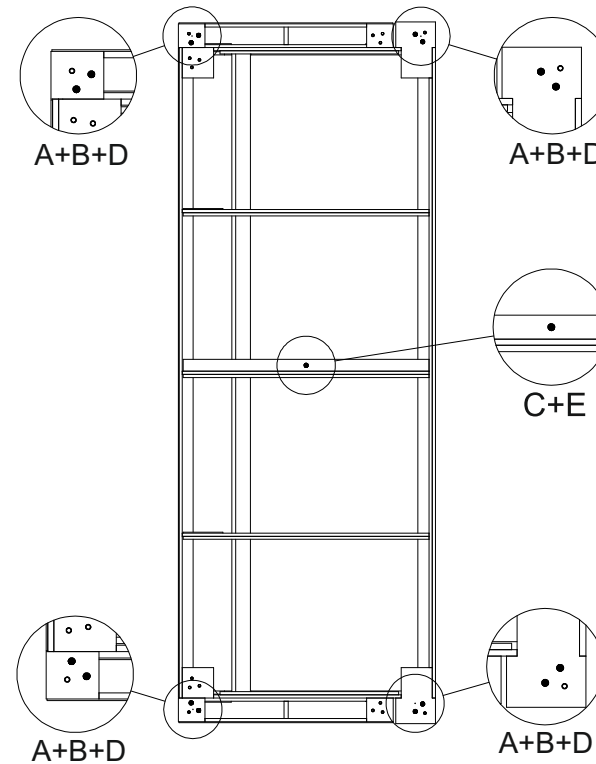
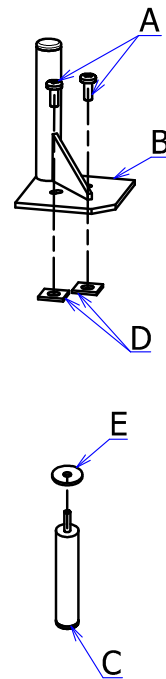

## IMPORTANT

At least two people are necessary to lift the sofa, do not lift the sofa alone or push it.  
It may cause damage in the connecting mechanisms and may create creaking noise in furniture.  
The sofa has to be placed on a flat and leveled surface.

VILMERS